

# PROFIXER LINE SYSTEM

ZERO CURVE INSERTS + NYLON ANCHORS + BASE  
WOODEN FINISHES AND ANODIZED FINISHES

The **PROFIXER LINE SYSTEM** comprises an assortment of profiles in aluminium with a longitudinal dovetail groove/channel into which the anchors or the tap-down punched/perforated aluminium profile may be inserted for easy and invisible fixing.  
The profiles are covered with wooden finishes that are highly resistant to pedestrian traffic, wear, UV rays and commonly used floor cleaning products. Plus anodized finishes. The **PROFIXER LINE SYSTEM** profiles are recommended for floors up to 22.5 mm thick.

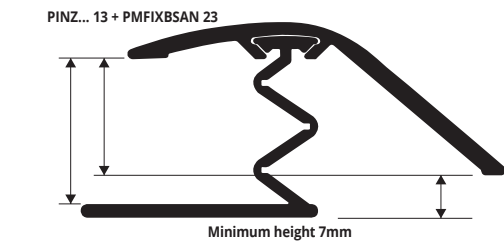
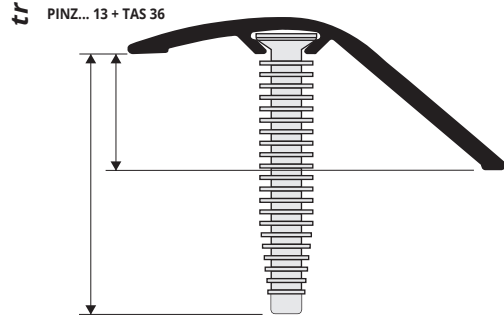
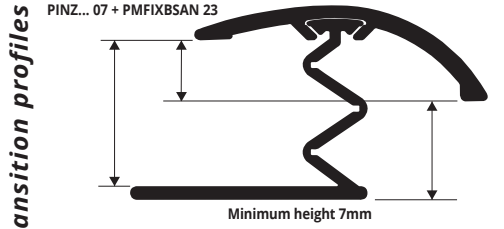

**ANODIZED ALUMINIUM (6 anod. alum. finishes of which 3 on demand)**  
thermo packed - bar length 2,7 lm - pack. 20 Pcs - 54 lm

Article	L mm	H mm
PINZ... 07	40	7 - 13
PINZ... 13	47	15 - 17

Available in the finishes: AO - AA - AB (AT, CH and SB available on demand with a minimum quantity order of 100 pcs) and in the wooden finishes: 04W - 05W - 07W - 09W - 13W - 18W - 21W - 25W - 29W - 30W - 31W - 32W - 33W - 34W - 35W - 36W - 37W - 38W - 39W - 41W - 42W - 44W - 45W - 46W - 48W - 49W - 53W - 54W - 55W - 65W - 73W - 75W.  
The code of the selected colour must be added to the article code. E.g.: PINZ... 07 (chosen finish anod. gold) PINZAO 07.



**ALUMINIUM COVERED (80 wooden finishes of which 49 on demand)**  
thermo packed - bar length 2,7 lm - pack. 20 Pcs - 54 lm

Article	L mm	H mm
PINZ... 07	40	7 - 13
PINZ... 13	47	15 - 17

**ANODIZED ALUMINIUM (6 anod. alum. finishes of which 3 on demand)**  
thermo packed - bar length 0,90 lm - 20 Pcs  
with 5 anchors 

Article	L mm	H mm
PINZ... 07S	40	7 - 13
PINZ... 13S	47	15 - 17

**ALUMINIUM COVERED (80 wooden finishes of which 49 on demand)**  
thermo packed 0,90 lm 20 Pcs 

Article	L mm	H mm
PINZ... 07S	40	7 - 13
PINZ... 13S	47	15 - 17

Available in the finishes: AO - AA - AB (AT, CH and SB available on demand with a minimum quantity order of 100 pcs) and in the wooden finishes: 04W - 05W - 07W - 09W - 13W - 18W - 21W - 25W - 29W - 30W - 31W - 32W - 33W - 34W - 35W - 36W - 37W - 38W - 39W - 41W - 42W - 44W - 45W - 46W - 48W - 49W - 53W - 54W - 55W - 65W - 73W - 75W.  
The code of the selected colour must be added to the article code. E.g.: PINZ... 07 (chosen finish anod. gold) PINZAO 07.

1. Choose the PROFIXER LINE SYSTEM profile in the required type and finish.
2. Cut the profile to the required length.
- 3a. For the version with screw anchors: make 5 drill holes per linear metre on the floor using a Ø 7mm drill, insert the anchors into the relative groove/channel of the profile and with the help of a rubber/plastic hammer, tap evenly over the surface until the anchor slots into the hole.
- 3b. For the version with tap-down aluminium base: first insert the base into the groove/channel of the "TOP" profile and then fix or glue the base to the floor; alternatively first fix or glue the base to the floor and then insert the 'profile'.
4. Close the profile, applying uniform pressure, either manually or with the help of a rubber hammer.

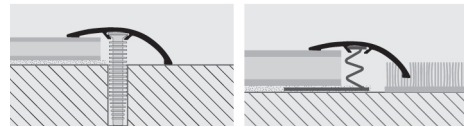

## EXAMPLES AND INSTRUCTIONS FOR LAYING METHODS



## COLOURS

**ANODIZED**

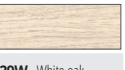
ON DEMAND - MINIMUM QUANTITY 200 PCS					
					
AO - Anod. gold aluminium	AA - Anod. silver aluminium	AB - Anod. bronze aluminium	AT - Anod. titanium aluminium	CH - Anod. champagne alum.	SB - Anod. sand aluminium

								
04W - Dark beech	05W - Light oak (strip)	07W - Light cherry (strip)	09W - Red walnut (merbau-apple-walnut)	13W - Indonesian teak	18W - Light zerbano	21W - Oak powder	25W - Bleached fir	29W - White oak
								
30W - Grey oak	31W - Victoria oak	32W - Pink oak	33W - Sawed oak	34W - Havana oak	35W - Edinburgh oak	36W - American oak	37W - Carvi oak	38W - Queens oak
								
39W - Grey elm	41W - Ice oak	42W - Grace oak	44W - Honey oak	45W - Marocco oak	46W - Black decape	48W - Cork oak	49W - Sand oak	53W
								
54W	55W	65W - Tripoli	73W - Bangkok	75W - Liotard				

On request it is possible to realize other finishes of the color range: minimum order 200 pcs. Production delay 4/5 weeks. Price to be agreed. For sample finishes, contact the sales office for minimum quantities, timing and costs.

# NYLON 36 SCREW ANCHORS AND TAP-DOWN BASE

**SCREW ANCHORS 36 - H 36 mm - pack. 20 Pcs**  
for SOL 30-40-50 and ZERO CURVE 07-15

Article	H mm
TAS 36	36

minimum order 5 pcs.

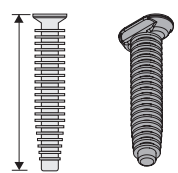

**PROFIXER TAP-DOWN BASE - ALUM. PUNCHED/PERFORED**  
for SOL 30-40-50 and ZERO CURVE 07-15  
bar length 2,7 lm - pack. 20 Pcs - 54 lm

Article	H mm
PMFIXBSAN 23	23

