

PROEXPAN 115-130-190-210 is a range of structural expansion joints in natural aluminium with knurled flat surface and a black or grey synthetic rubber insert. Made to withstand vertical, horizontal and transversal structural movements due to compressive and tensile stress in large buildings or complexes. The joint is laid on existing surfaces, also vertically, over the void between the two semi-detached surfaces of the same building or between two bays. It withstands frequent pedestrian traffic and also vehicles with rubber tyres that can load to 700 kgs. (PENF 190-210)

PROEXPAN 115-130-190-210

NATURAL ALUMINIUM
+ VINYL RESIN / RUBBER INSERT

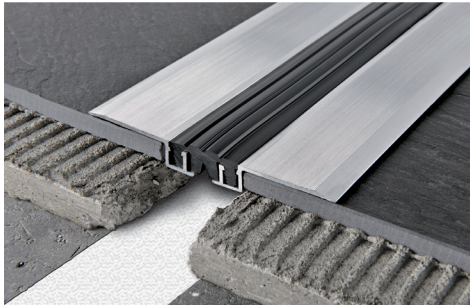

NATURAL ALUMINIUM + VINYL RESIN / RUBBER INSERT
bar length 2,7 lm - pack. 10 Pcs - 27 lm

Article	LxHxLa mm
PENF 115...	21 x 12 x 115
PENF 130...	38 x 12 x 128

NATURAL ALUMINIUM + NEOPRENE INSERT
bar length 3 lm - pack. 10 Pcs - 30 lm

Article	LxHxLa mm
PENF 190N	65 x 19 x 185
PENF 210...	90 x 19 x 210

Movement mm: -10/+16 (PENF 190N) -15/+10 (PENF 210...)
Available in the colours: G - N (PENF 190N excluded).
The code of the selected finish must be added to the article code.
E.g.: PENF 130... (chosen insert colour grey) PENF 130G.

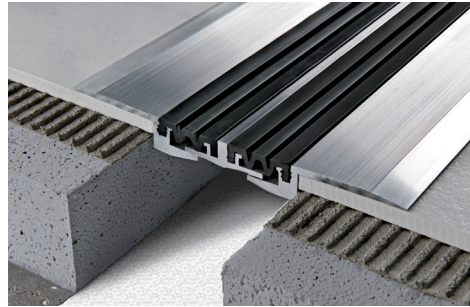

INTERCHANGEABLE INSERT IN VINYL RESIN/RUBBER INSERT
BLACK OR GREY - bar length 3 lm - pack. 10 Pcs - 30 lm

Article	L mm
IPEN 20...	20
IPEN 40...	35

INTERCHANGEABLE NEOPRENE INSERT BLACK OR GREY
bar length 4 lm - pack. 10 Pcs - 40 lm

Article	L mm
IPEN 65N	65
IPEN 452...	45 x 2

Insert available in the colours: G - N (IPEN 65N excluded).
The code of the selected finish must be added to the article code.
E.g.: IPEN 20... (chosen insert colour grey) IPEN 20G.

PENF 115...

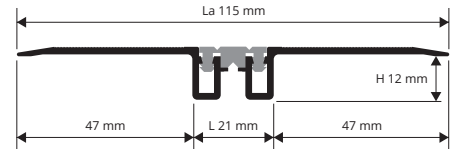

PENF 130...

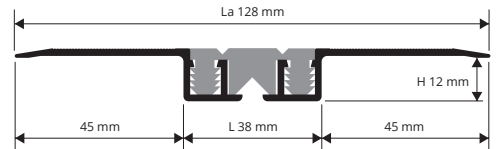

EXAMPLES AND INSTRUCTIONS FOR LAYING METHODS

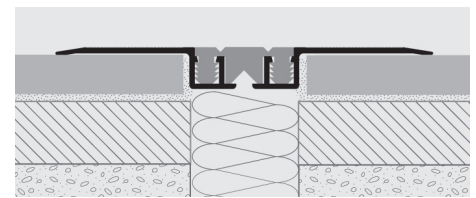

Fix the side wings/flanges in aluminium with:
1. Screws and screw anchors at 20 cm intervals along both sides of the whole joint
2. Two-pack epoxy adhesive or with strong fast-setting silicone.

Due to the nature of the product itself, natural aluminium, and its specific use on the floor as technical joint with no decorative role, light scratches on its surface will not be accepted for claims.

INSERT COLOURS



ON DEMAND - MINIMUM QUANTITY 100 lm
ONLY FOR: PENF 115, PENF 130

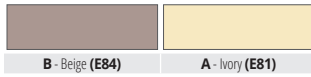

(Price to be agreed. Production delay 4/5 weeks)

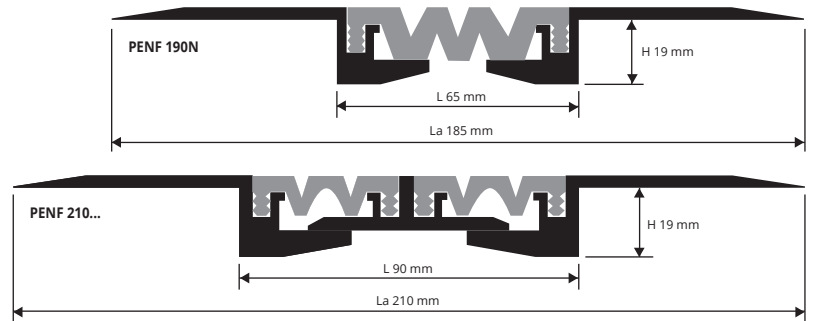

ANGLES BAR / WALL

NATURAL ALUMINIUM + NEOPRENE INSERT

ANGLE BAR NATURAL ALUMINIUM + NEOPRENE INSERT
bar length 3 lm - pack. 10 Pcs - 30 lm

Article	LxHxLa mm
PENFP 190N	65 x 19 x 125
PENFP 210..	90 x 19 x 150

INTERCHANGEABLE BLACK OR GREY VINYL RESIN/RUBBER INSERT
bar length 3 lm - pack. 10 Pcs - 30 lm

Article	L mm
IPEN 65N	65
IPEN 452...	45 x 2 Pz

Available in the colours: G - N.
The code of the selected finish must be added to the article code.
E.g.: PENFP 210... (chosen insert colour grey) PENFP 210G.

PRODUCT SUPPLIED NOT ASSEMBLED

Due to the nature of the product itself, natural aluminium, and its specific use on the floor as technical joint with no decorative role, light scratches on its surface will not be accepted for claims.

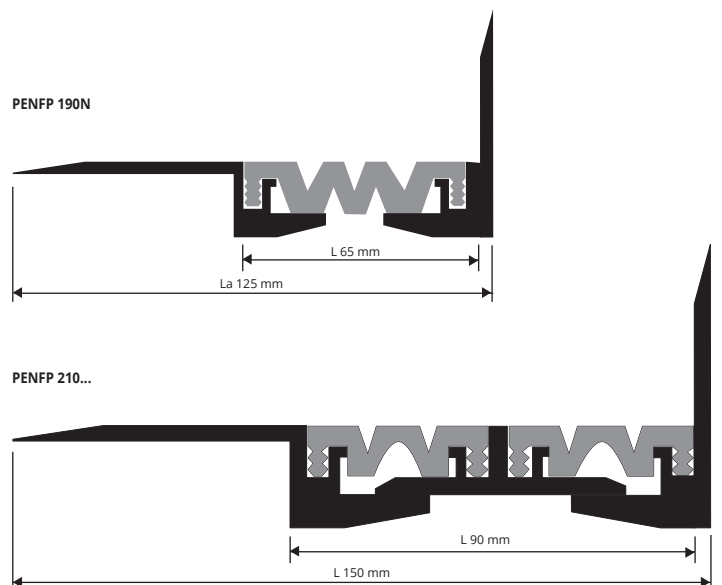

* = Production on demand with minimum quantity of 100 pcs. Production delay 4/5 weeks. Price to be agreed